

Article number: 2310301746ESD

Description: E+G Antistatic base for levelling elements
LV.A-70-14-AS-ESD-C

Measures

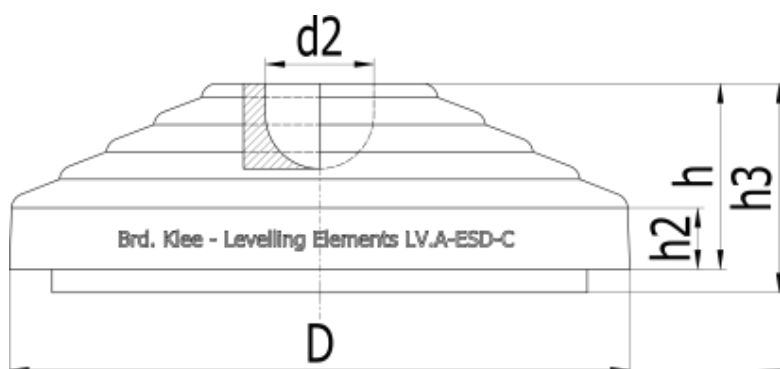

D	= 70
d2	= 14
h	= 19
h2	= 7
h3	= 22
N	= 14000
Weight in g	= 30